





USE RANGE		TOLERANCE		SURFACE		PROJECTION 		FORMAT A3	SCALE 1:5	DIM. mm
ONLY FOR INFORMATION		x ± 0.5mm				PROJECT <b>BWP</b>				
		x.0 ± 0.1mm								
			DATE	NAME		SUBJECT <b>muurframe</b>				
			DRAWN 10-10-2013	HWB						
			APPR.							
			RLS.							
						DRAWING-NUMBER <b>xxx-xxxx-000</b>				
REV	DESCRIPTION	DATE	NAME			ORIGINAL	Sheet: 1 DRAWING FORMAT A3			

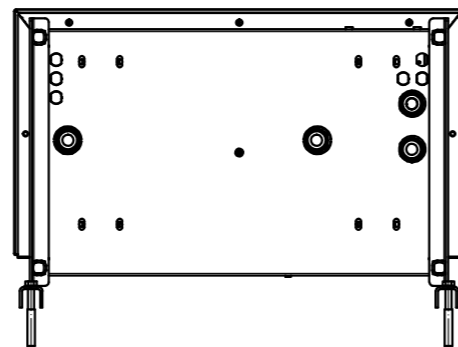
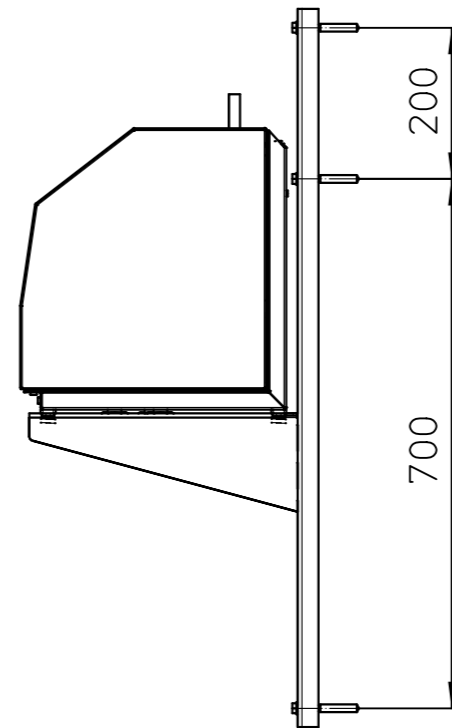
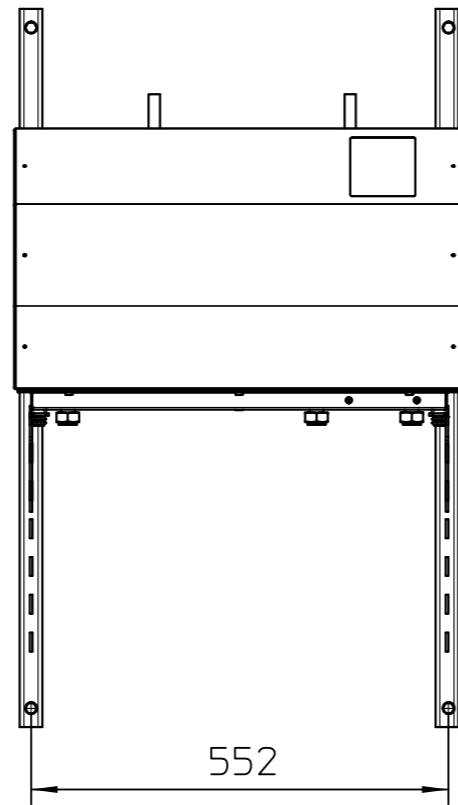

USE RANGE		TOLERANCE		SURFACE		PROJECTION 		FORMAT A4		SCALE 1:5		DIM. mm		
FOR INFORMATION ONLY						PROJECT		BWP						
		DATE		NAME		SUBJECT								
		DRAWN 10-10-2013		HWB		Muurframe								
		APPR.												
		RLS.												
						DRAWING-NUMBER		xxx-xxxx-000						
REV	DESCRIPTION	DATE	NAME	ORIGINAL			I.EXCH.F.		DRAWING FORMAT A4					